



# Model 3142E

## BiConiLog™ Antenna

---



### User Manual

PN: 399337

August, 2022

Rev E

ETS-Lindgren Inc. reserves the right to make changes to any products herein to improve functioning or design. Although the information in this document has been carefully reviewed and is believed to be reliable, ETS-Lindgren does not assume any liability arising out of the application or use of any product or circuit described herein; nor does it convey any license under its patent rights nor the rights of others. All trademarks are the property of their respective owners.

**© Copyright 2012 - 2022 written permission from ETS-Lindgren Inc. All Rights Reserved. No part of this document may be copied by any means without written permission from ETS-Lindgren Inc.**

Trademarks used in this document: The *ETS-Lindgren* logo is a registered trademark of ETS-Lindgren, Inc.; *Teflon* is a registered trademark of E. I. du Pont de Nemours and Company or its affiliates.

### Revision Record

MANUAL, 3142E | Part # 399337 Rev E

Revision	Description	Date
A	Initial Release	July, 2012
B	Updated frequency range; updated boom options	February, 2015
C	Updated manual format and added typical data for cross polarization	February, 2021
D	Updated Assembly photo captions to correct polarization	July, 2021
E	Corrected cross references	August, 2022

# TABLE OF CONTENTS



---

<b>NOTES, CAUTIONS AND WARNINGS</b>	<b>5</b>
<b>INTRODUCTION</b>	<b>6</b>
Tripod Options . . . . .	.7
ETS-Lindgren Product Information Bulletin . . . . .	.7
<b>MAINTENANCE</b>	<b>8</b>
Replacement and Optional Parts . . . . .	.8
Service Procedures . . . . .	.8
Contacting ETS-Lindgren . . . . .	.8
Sending a Component for Service . . . . .	.8
Calibration Services and Annual Calibration . . . . .	.8
<b>SPECIFICATIONS</b>	<b>9</b>
Electrical Specifications . . . . .	.9
<b>ASSEMBLY</b>	<b>10</b>
Attach Bowtie Elements . . . . .	10
<b>MOUNTING</b>	<b>12</b>
Using Included Mounting Adapters . . . . .	.12
Using the Stinger to Mount to a Model 2175 MiniMast	13
Additional Mounting Options . . . . .	.15
4-TR Mounting Options . . . . .	.15
7-TR and Mast Mounting Options . . . . .	.16
2X2 Boom Mounting Options . . . . .	.17
<b>TYPICAL DATA</b>	<b>18</b>
Typical Antenna Factor and Gain . . . . .	.18
Typical VSWR . . . . .	.19
Typical Half Power Beamwidth . . . . .	.19
Typical Radiation Patterns . . . . .	20
30MHz-50MHz . . . . .	20
70MHz-90MHz . . . . .	20
100 MHz-200MHz . . . . .	.21
300MHz-400MHz . . . . .	.21
500MHz-600MHz . . . . .	22

700MHz-800MHz . . . . .	22
900MHz-1000MHz . . . . .	23
2000MHz-3000MHz . . . . .	23
4000MHz-5000MHz . . . . .	24
6000MHz . . . . .	24
Typical Cross Polarization . . . . .	25

## NOTES, CAUTIONS AND WARNINGS

---

	<b>Note:</b> Denotes helpful information intended to provide tips for better use of the product.
	<b>CAUTION:</b> Denotes a hazard. Failure to follow instructions could result in minor personal injury and/or property damage. Included text gives proper procedures.
	<b>WARNING:</b> Denotes a hazard. Failure to follow instructions could result in <b>SEVERE</b> personal injury and/or property damage. Included text gives proper procedures.

\*All notes, cautions, and warnings will be located on the left column area of the page.



See the ETS-Lindgren **Product Information Bulletin** for safety, regulatory, and other product marking information

## INTRODUCTION

The ETS-Lindgren **Model 3142E BiConiLog™ Antenna** is designed as a dual-purpose antenna that can be used for both immunity and emission testing. From 30 MHz to 6 GHz, the Model 3142E exhibits an average 5.5 dB gain. Applications for the Model 3142E include emissions testing, immunity measurements, and medical equipment testing.



**Model 3142E shown in vertical polarization**

The Model 3142E Antenna includes a stinger mount; it also includes a mounting bracket and a 1/4–20 thread knob to attach to an ETS-Lindgren tripod or tower adapter.

For the variety of mounting options available for the Model 3142E, see Mounting instructions.

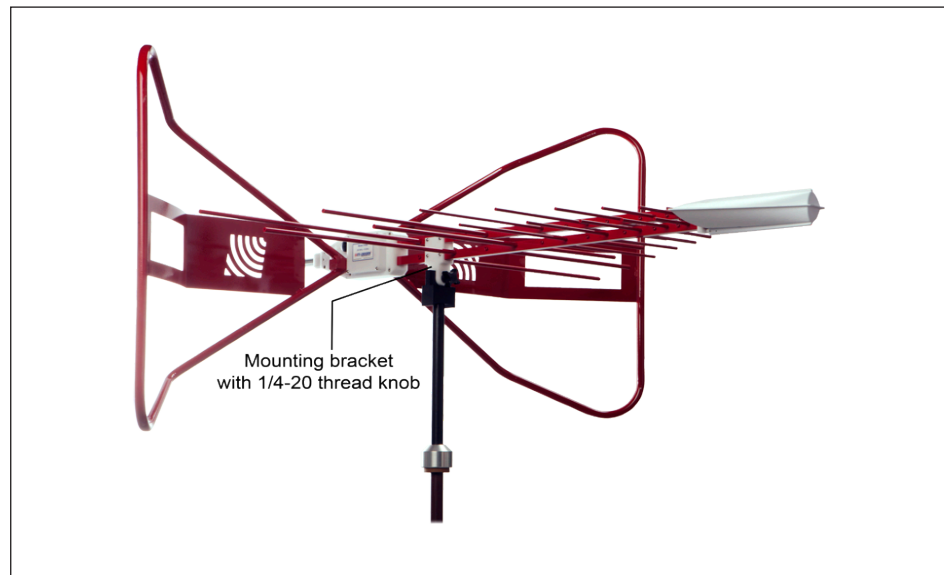

**Model 3142E shown in horizontal polarization**



**Note:**

For easy horizontal and vertical polarization, the ETS-Lindgren Model 7-TR tripod is recommended.

## Tripod Options

ETS-Lindgren offers the following non-metallic, non-reflective tripods for use at both indoor and outdoor EMC test sites.

- 4-TR Tripod—Constructed of linen phenolic and delrin, designed with an adjustable center post for precise height adjustments. Maximum height is 2.0 m (80.0 in), and minimum height is 94 cm (37.0 in). This tripod can support up to an 11.8 kg (26.0 lb) load.



- 7-TR Tripod—Constructed of PVC and fiberglass components, providing increased stability for physically large antennas. The unique design allows for quick assembly, disassembly, and convenient storage. Allows several different configurations, including options for manual or pneumatic polarization. Quick height adjustment and locking wheels provide ease of use during testing. Maximum height is 2.17 m (85.8 in), with a minimum height of 0.8 m (31.8 in). This tripod can support a 13.5 kg (30 lb) load.



## ETS-Lindgren Product Information Bulletin

See the ETS-Lindgren *Product Information Bulletin* included with your shipment for the following:

- Safety, regulatory, and other product marking information
- Steps to receive your shipment
- Steps to return a component for service
- ETS-Lindgren calibration service
- ETS-Lindgren contact information

**CAUTION**

Before performing any maintenance, follow the safety information in the ETS-Lindgren Product Information Bulletin included with your shipment.

**WARNING**

Maintenance of the Model 3142E is limited to external components such as cables or connectors.



If you have any questions concerning maintenance, contact ETS-Lindgren Customer Service.



**Note:**

ETS-Lindgren may substitute a similar part or new part number with the same functionality for another part/part number. Contact ETS-Lindgren for questions about part numbers and ordering parts.

For additional/optional mounting hardware, see Additional Mounting Options.

# MAINTENANCE

## Replacement and Optional Parts

The following are the part numbers for ordering replacement or optional parts for the Model 3142E.

Part Description	Part Number
Polarizing Mounting Adapter	100989
Thread Insert	105861

## Service Procedures

### Contacting ETS-Lindgren

Please see [www.ets-lindgren.com](http://www.ets-lindgren.com) for a list of ETS-Lindgren offices, including phone and email contact information.

### Sending a Component for Service

For the steps to return a system or system component to ETS-Lindgren for service, see the Product Information Bulletin included with your shipment.

### Calibration Services and Annual Calibration

See the Product Information Bulletin included with your shipment for information on ETS-Lindgren calibration services.



# SPECIFICATIONS

## Electrical Specifications

<b>Frequency Range:</b>	30 MHz–6 GHz		
<b>Input Impedance (Nominal):</b>	50 $\Omega$		
<b>VSWR (Average):</b>	2:1 above 50 MHz		
<b>Maximum Continuous Power</b>		<b>Continuous</b>	<b>Peak</b>
	30 MHz-60 MHz:	500 W	800 W
	60 MHz-600 MHz:	1 kW	1.5 kW
	600 MHz-1 GHz:	500 W	800 W
	1 GHz-6 GHz:	200 W	300 W
<b>Peak Power:</b>	1.3 kW		
<b>Pattern Type:</b>	Directional		
<b>Polarization:</b>	Linear		
<b>Connector:</b>	Type N female		

## Physical Specifications

<b>Height (Overall):</b>	76.2 cm (30 in)
<b>Length:</b>	139.16 cm (54.79 in)
<b>Width:</b>	133.75 cm (52.66 in)
<b>Weight:</b>	5.7 kg (12.5 lb)

## ASSEMBLY

### CAUTION

Before connecting any components, follow the safety information in the ETS-Lindgren Product Information Bulletin included with your shipment.

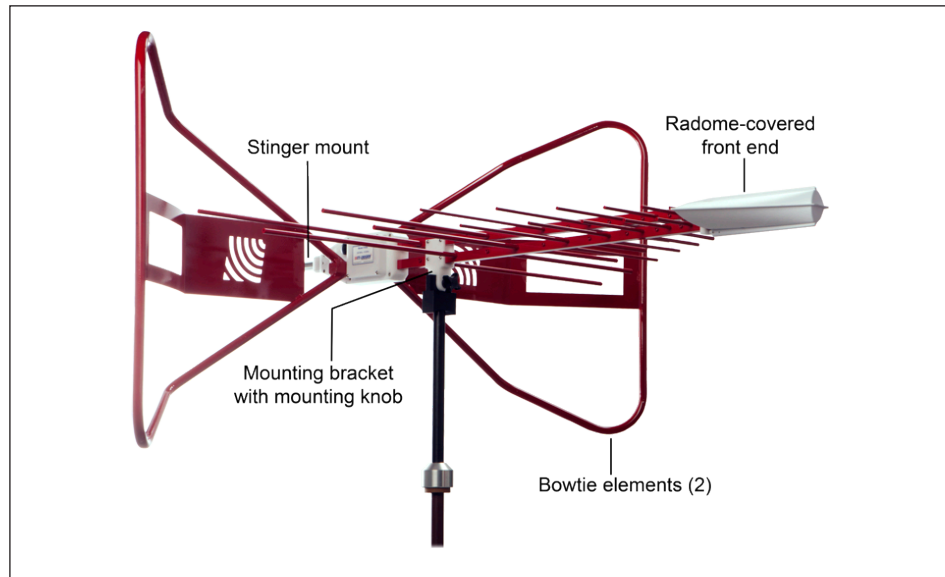

**Model 3142E Overall Assembly**

The Model 3142E BiConiLog™ Antenna is comprised of the following parts:

- Antenna
- Bowtie elements (2)
- 10–32 thumbscrew knobs to attach bowtie elements (2)
- Mounting bracket and mounting knob

### Attach Bowtie Elements

The Model 3142E ships with the bowtie elements detached. To attach the bowtie elements:

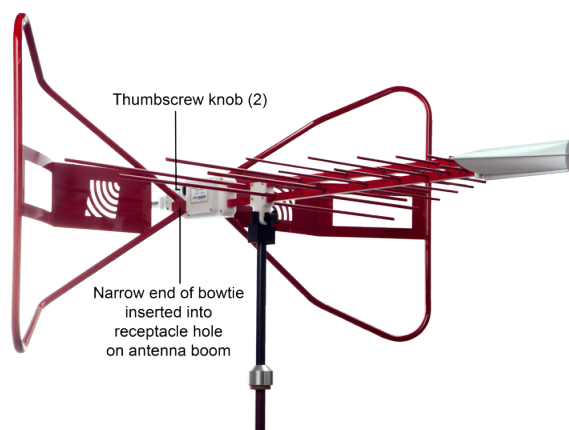

#### Note:

Photos of bowtie elements used in this section may differ from the bowtie elements for your Model 3142E; the assembly procedure is the same for both.

1. For stability, mount the Model 3142E onto a tripod or tower. See Mounting Instructions on page 19 for the steps to mount the antenna.

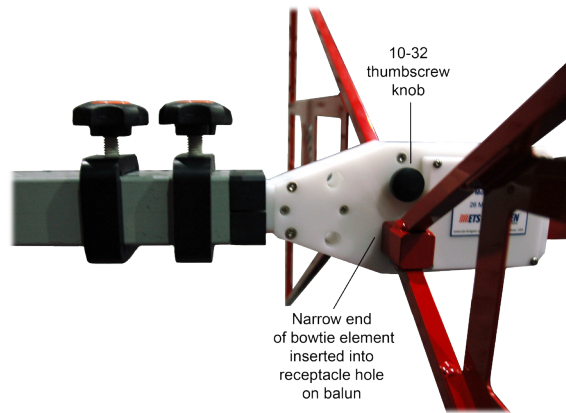

## CAUTION

Do not cross thread this connection or permanent damage to the bowtie element could occur.

2. Slide the narrow end of one of the bowtie elements into the receptacle hole on the antenna balun, and then align the bowtie with the receptacle on the balun.
3. Insert one of the 10–32 thumbscrew knobs into the opposite side of the balun from where you inserted the bowtie. Slowly tighten the knob, taking care not to cross thread the connection.
4. Repeat steps 2 and 3 for the second bowtie element.

## CAUTION

Before connecting any components, follow the safety information in the ETS-Lindgren Product Information Bulletin included with your shipment.

The Model 3142E antenna is a precision measurement device. Handle with care.



### Note:

Photos of bowtie elements used in this section may differ from the bowtie elements for your Model 3142E; the assembly procedure is the same for both.

## MOUNTING

Contact with any metal or non-metallic structure can capacitively load the antenna, which may cause unrepeatable results. Therefore, make sure that no part of the dipole elements or bowties is in contact with the tripod or tower, particularly in vertically-polarized tests. Where possible, run the feed cable straight one meter or more back from the Model 3142E BiConiLog™ Antenna before dropping vertically.

### Using Included Mounting Adapters

In addition to the attached mounting bracket and mounting knobs, the Model 3142E ships with these mounting adapters:

1. 100989 Polarizing Mounting Adapter with 7/8-14 thread receptacle

- If you need to convert the polarizing adapter to a 1/4-20 receptacle, insert the 1/4-20 thread insert into the polarizing adapter

2. 105861 1/4-20 Thread Insert

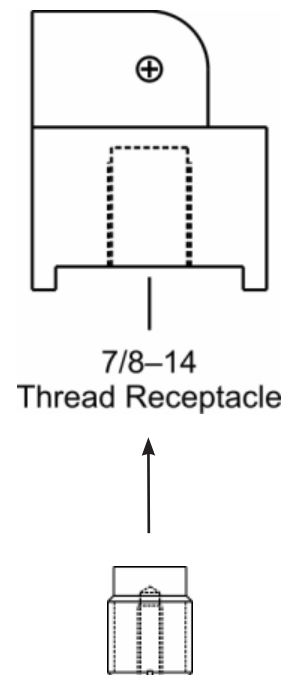

## To attach the included adapters to the Model 3142E:

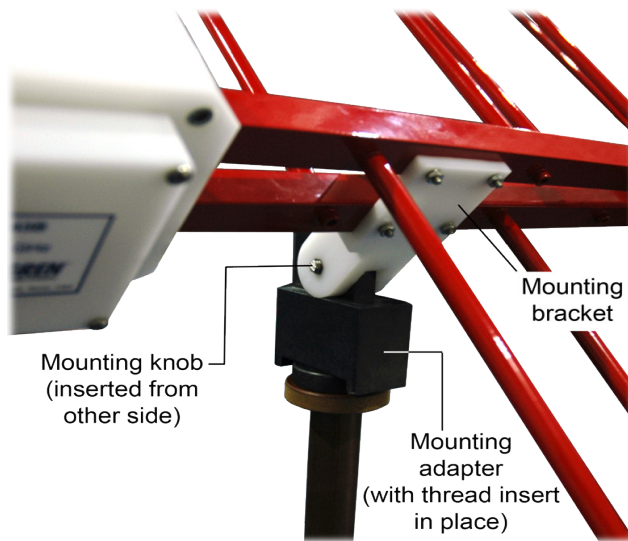

Model 3142E mounted onto 4-TR using included 100989 Polarizing Mounting Adapter and 105861 1/4-20 Thread Insert

### CAUTION

Do not cross thread or permanent damage to the adapter and thread insert could occur.

1. If required, insert the 1/4-20 thread insert into the mounting adapter.
2. Remove the mounting knob from the mounting bracket on the antenna.
3. Slide the mounting bracket onto the mounting adapter with the adapter placed between the shoulders of the mounting bracket.
4. Thread the mounting knob through the mounting bracket, then through the mounting adapter, and finally through the hex nut.
5. Tighten the mounting knob to secure the antenna.
6. Attach the mounting adapter and antenna to tripod or tower, as required.

## Using the Stinger to Mount to a Model 2175 MiniMast

The stinger mount provides on-axis rotation during 90° horizontal or vertical polarization. The stinger enables you to mount the antenna directly to an ETS-Lindgren 7-TR Tripod or mast.



### Note:

Do not use the stinger to mount the Model 3142E onto a 4-TR tripod.

Before you begin –

- Install the center rotate boom (part# 108507) for rear-mount stinger-type antennas.
- Attach the included mounting adapter to the Model 3142E as instructed in *"Using Included Mounting Adapters"* on page 12 .
- You will need one of the optional mounting knobs described in *"7-TR and Mast Mounting Options"* on page 16. To order optional mounting hardware, contact the ETS-Lindgren Sales Department.

## CAUTION

Before connecting any components, follow the safety information in the ETS-Lindgren Product Information Bulletin included with your shipment.

The Model 3142E antenna is a precision measurement device. Handle with care.



### Note:

Photos of bowtie elements used in this section may differ from the bowtie elements for your Model 3142E; the assembly procedure is the same for both.

1. Thread the antenna feed or receiving cable through the center of the boom so that the antenna connector emerges a few inches out of the clamp end of the boom.

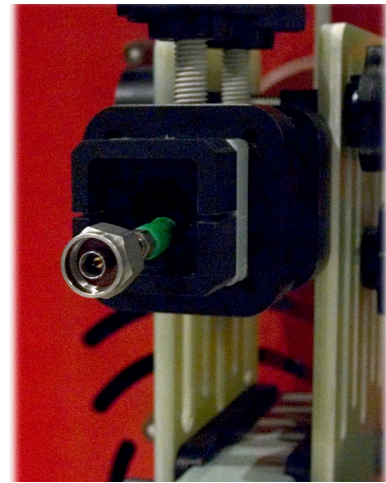

2. Attach the cable to the Type N connector at the end of the stinger.

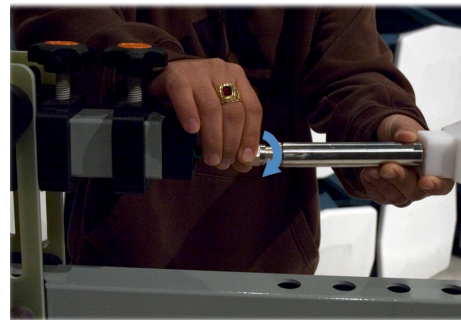

3. Slide the cable and stinger into the clamp on the boom, carefully guiding the cable out the other end.

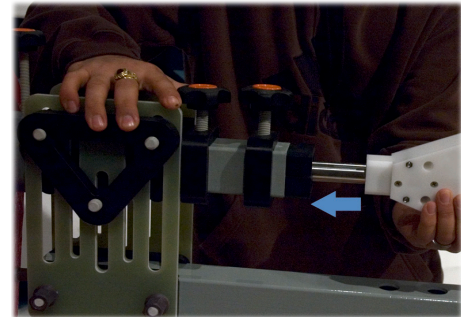

4. When you reach the back of the balun box, align it with the boom receptacle, and then slide the smaller portion of the balun box into the boom. This will prevent rotation of the antenna unless the boom is being polarized.

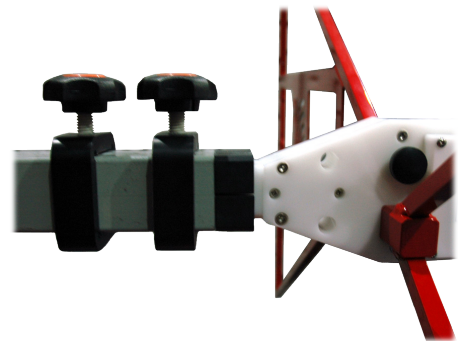

5. Tighten the clamp knobs on the boom to secure the antenna into place.



## Additional Mounting Options

### 4-TR Mounting Options

Following are additional options for mounting the Model 3142E onto an ETS-Lindgren 4-TR tripod. Contact the ETS-Lindgren Sales Department for information on ordering optional mounting hardware.

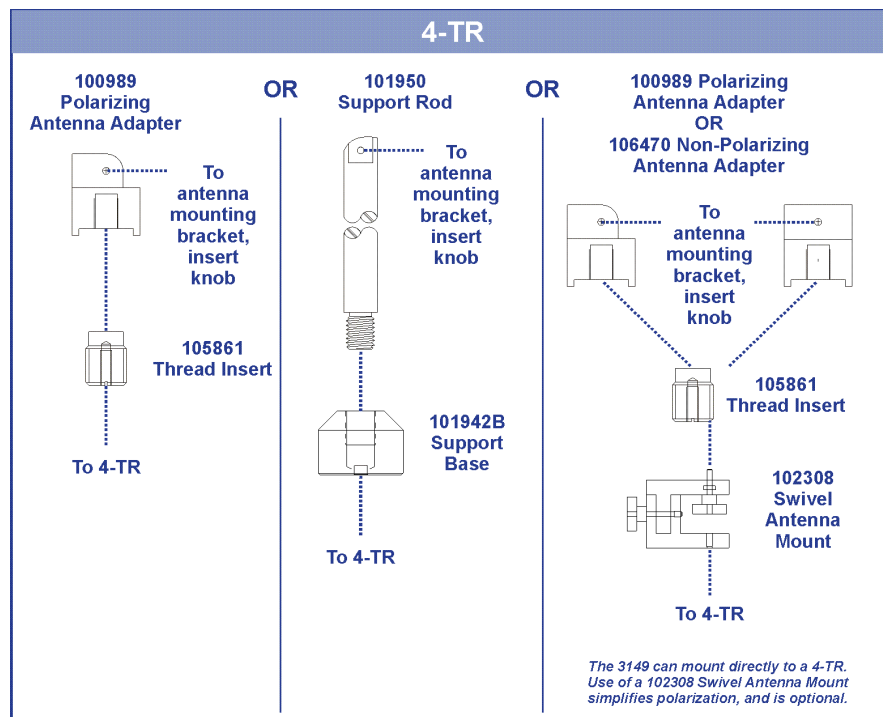



## 7-TR and Mast Mounting Options

The stinger on the Model 3142E enables you to mount to antenna directly to an ETS-Lindgren 7-TR Tripod Positioner.

However, following are additional options for mounting the Model 3142E onto an ETS-Lindgren 7-TR Tripod Positioner.

Contact the ETS-Lindgren Sales Department for information on ordering optional mounting hardware.

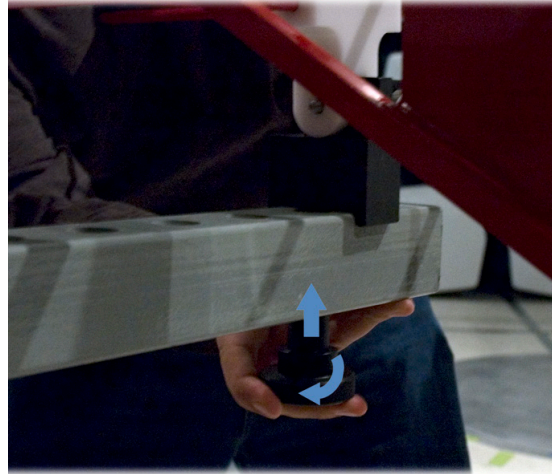

Non-stinger method to mount Model 3142E to 7-TR



**Note:**

Mast refers to 2070 Series, 2075, and 2175 Antenna Towers.

7-TR refers to these booms –

- 109042 boom—Straight boom; for general antenna mounting on a 7-TR
- 108983 boom—Offset boom; for general antenna mounting on a 7-TR with pneumatic or manual polarization; can also be used to mount stinger-type antennas
- 118947 – for stinger-type antennas only

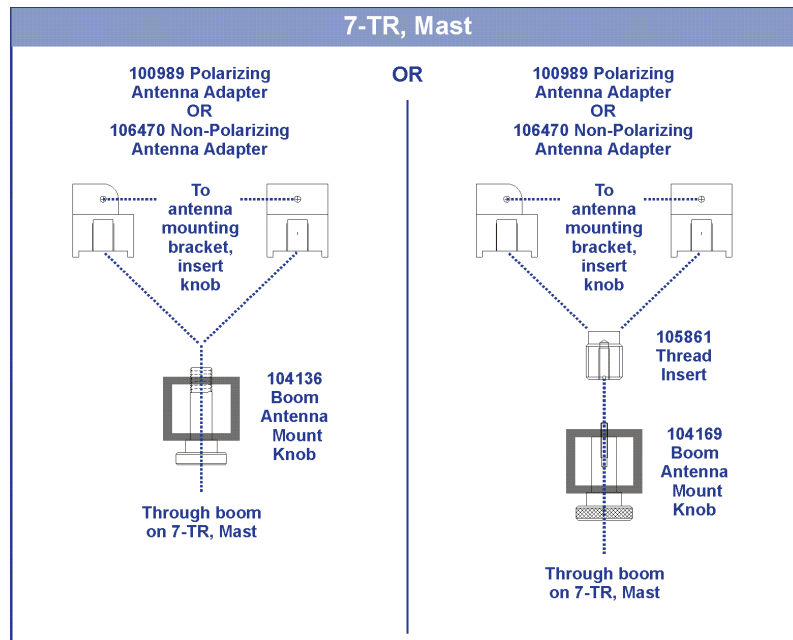





**Note:**

2x2 boom refers to a typical 2-inch by 2-inch boom.

## 2X2 Boom Mounting Options

Following are additional options for mounting the Model 3142E onto a 2x2 boom. Contact the ETS-Lindgren Sales Department for information on ordering optional mounting hardware.

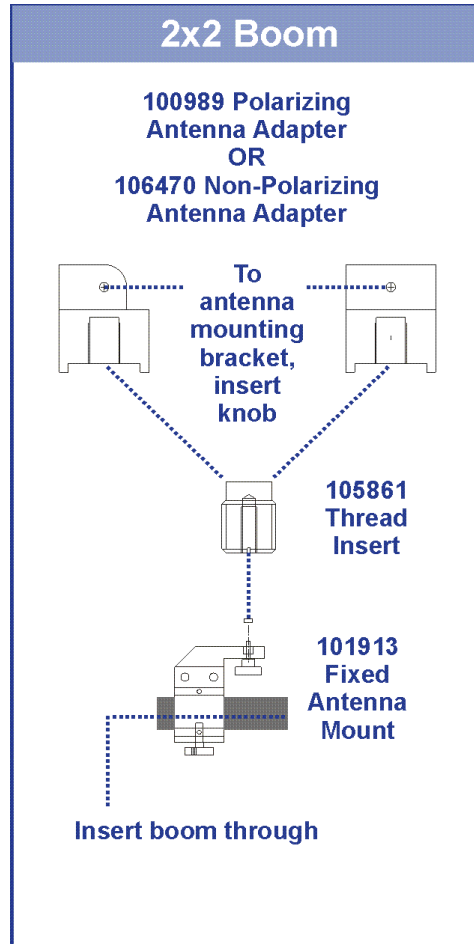

# TYPICAL DATA

## Typical Antenna Factor and Gain

Distance for the ANSI 3-meter and 10-meter calibrations is measured from the antenna midpoint, and for SAE 1-meter calibrations the distance is measured from the antenna tip. Midpoint is defined as half the distance between the small elements and the bowties, which is about 45 cm from the small end tip.

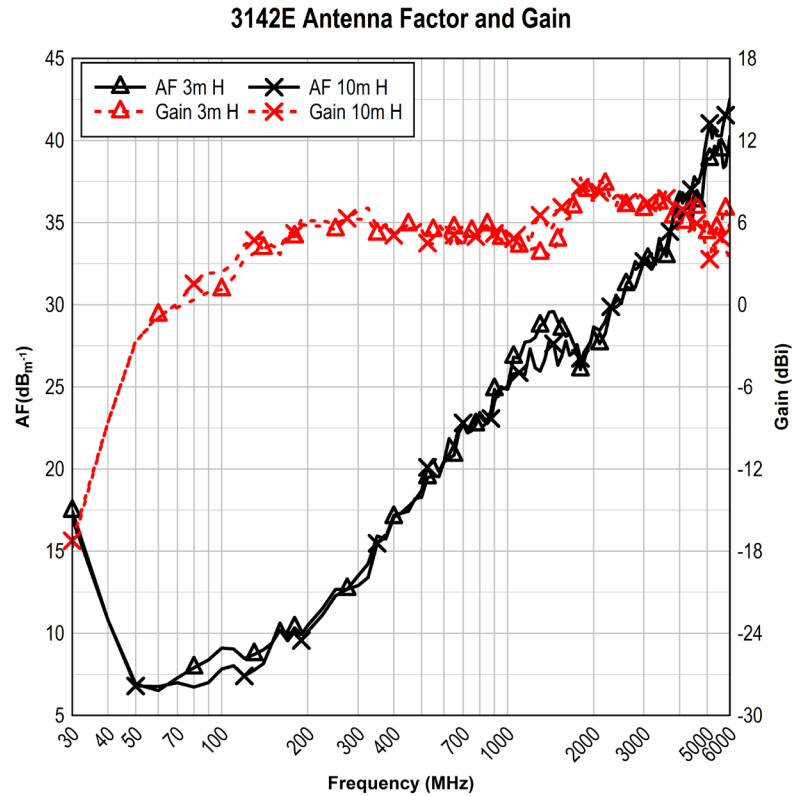

## Typical VSWR

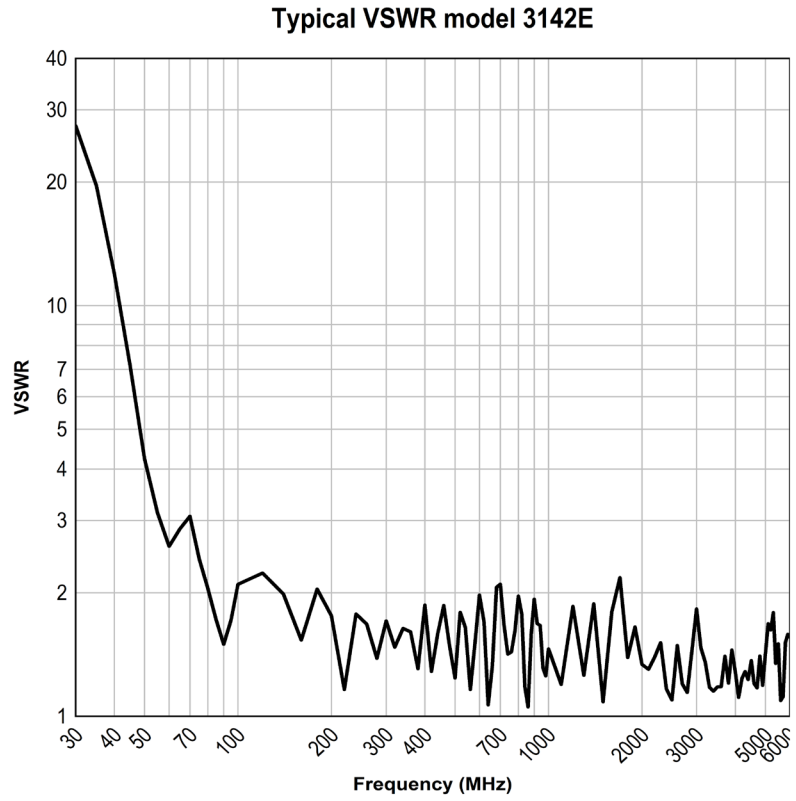

## Typical Half Power Beamwidth

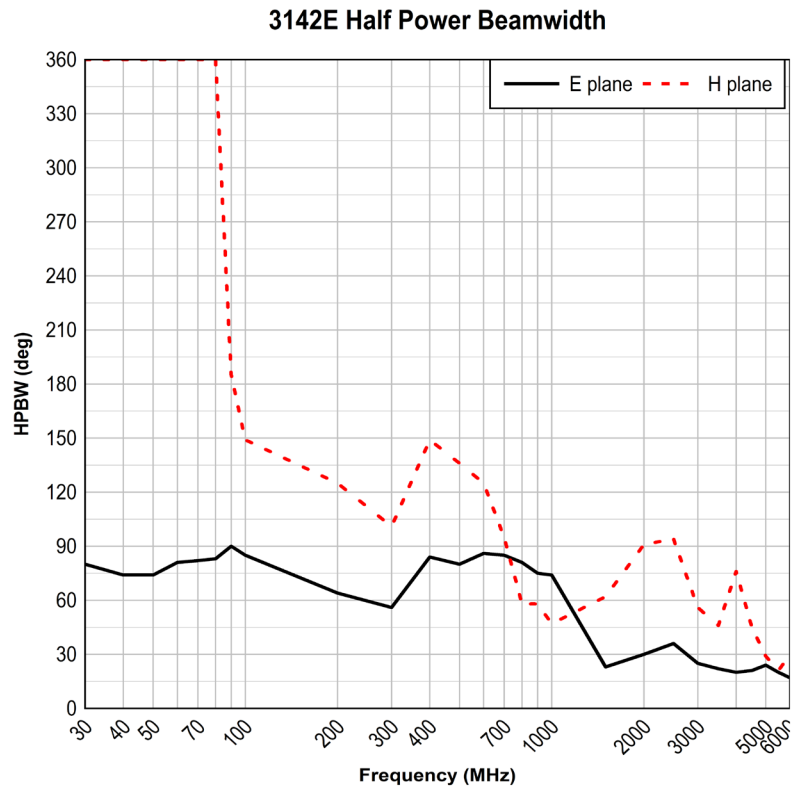

# Typical Radiation Patterns

## 30MHz-50MHz

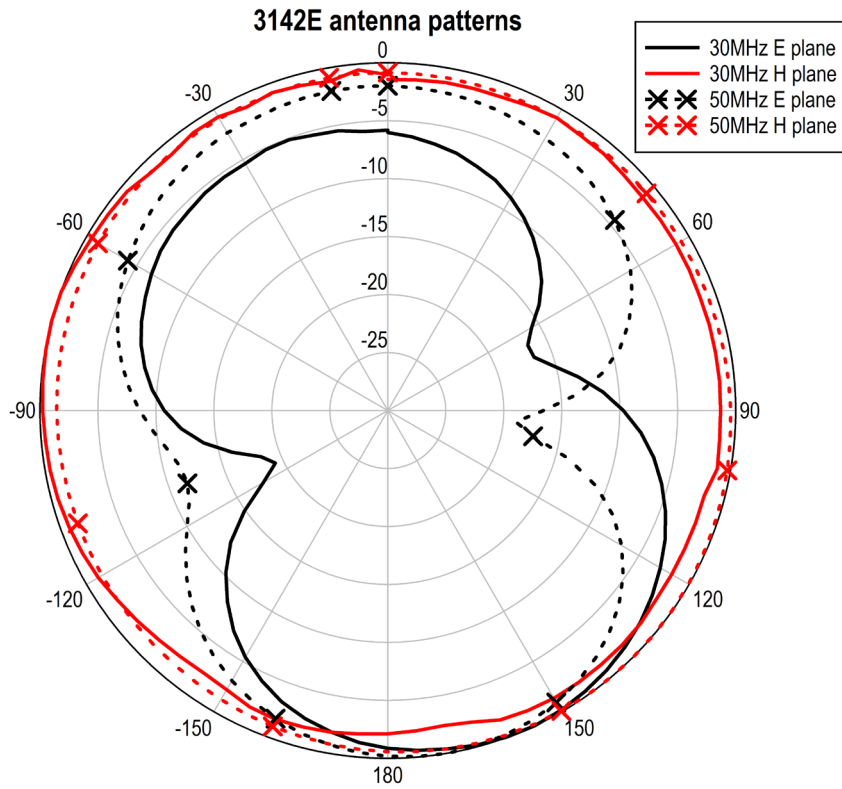

## 70MHz-90MHz

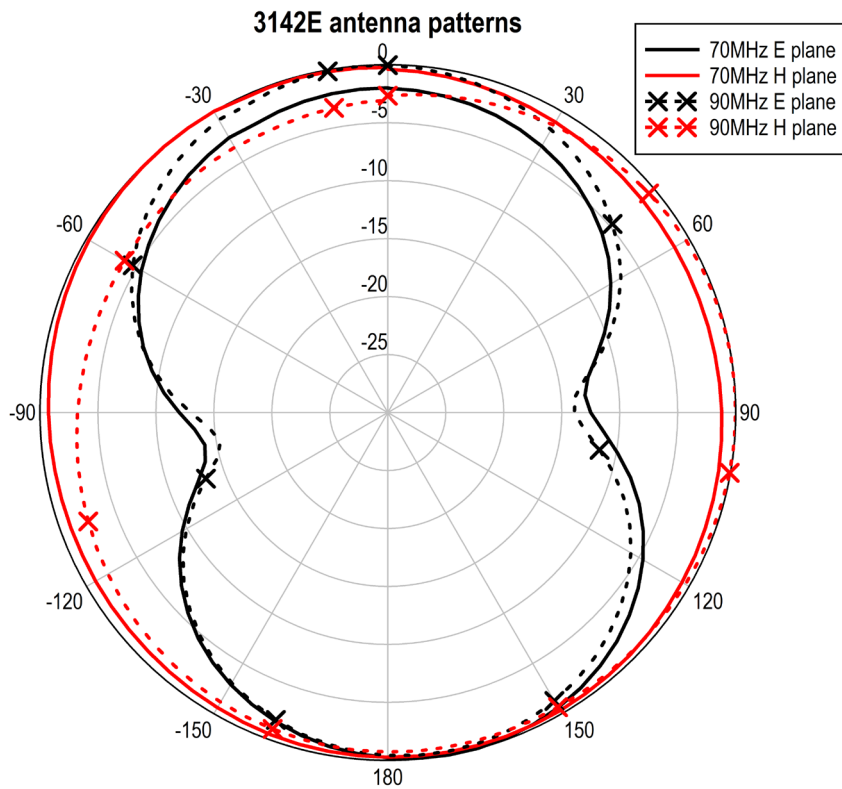

## 100 MHz-200MHz

### 3142E antenna patterns

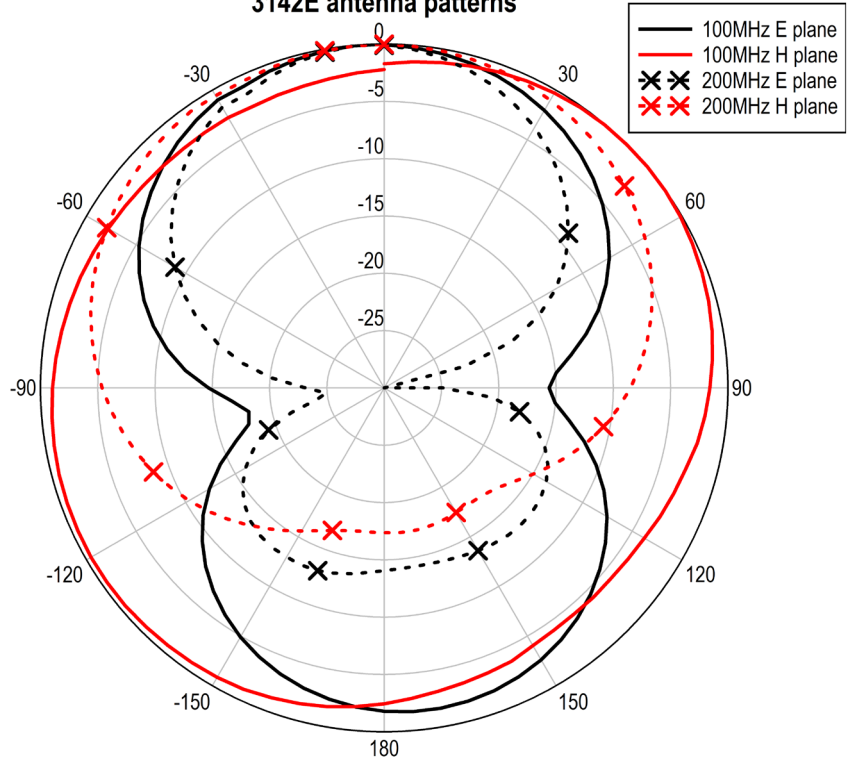

## 300MHz-400MHz

### 3142E antenna patterns

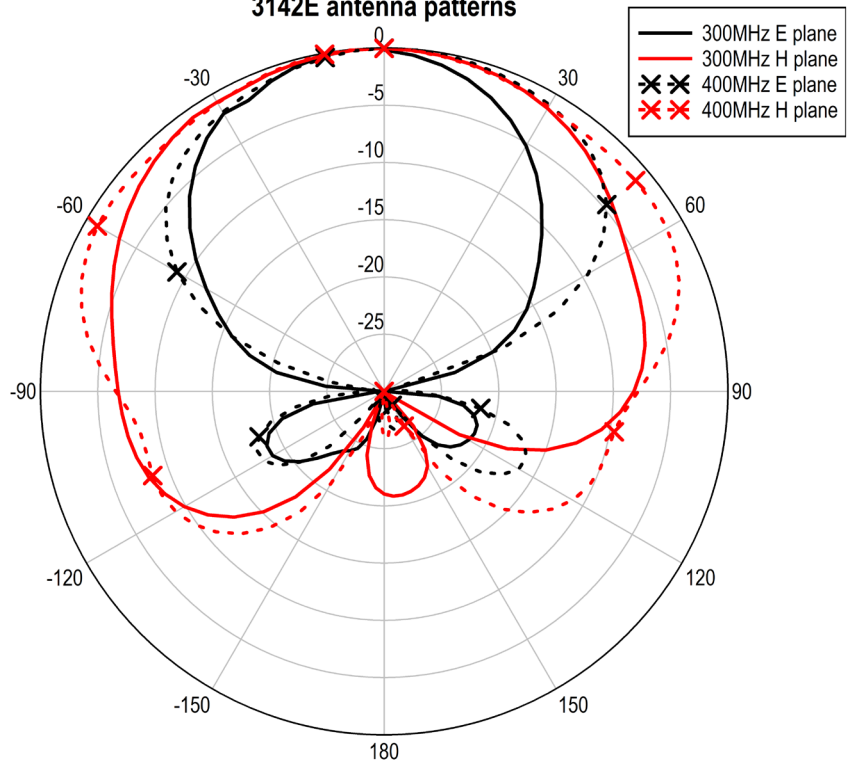

## 500MHz-600MHz

### 3142E antenna patterns

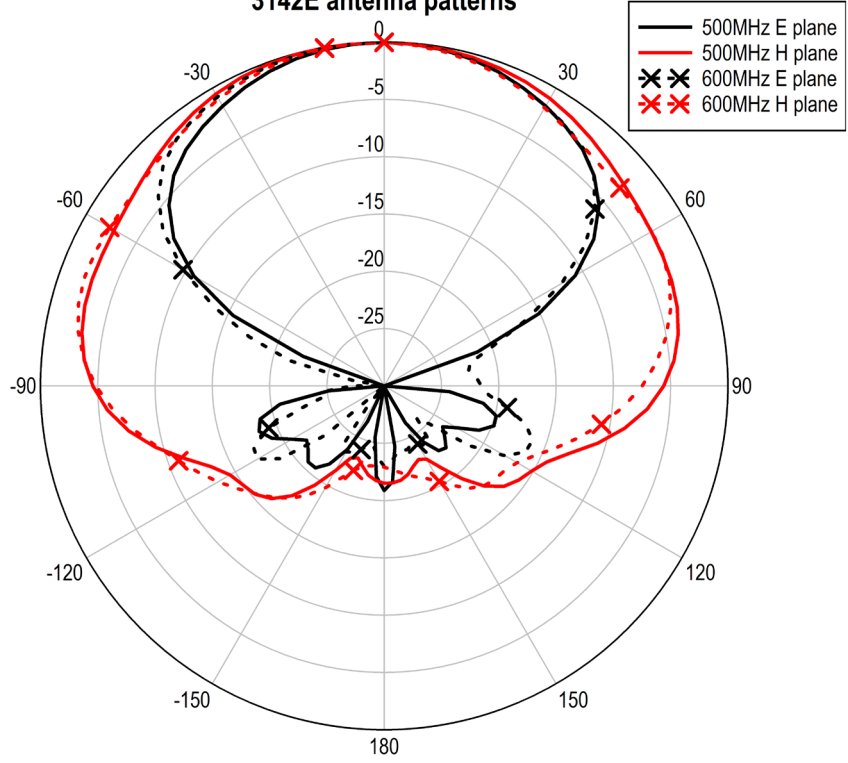

## 700MHz-800MHz

### 3142E antenna patterns

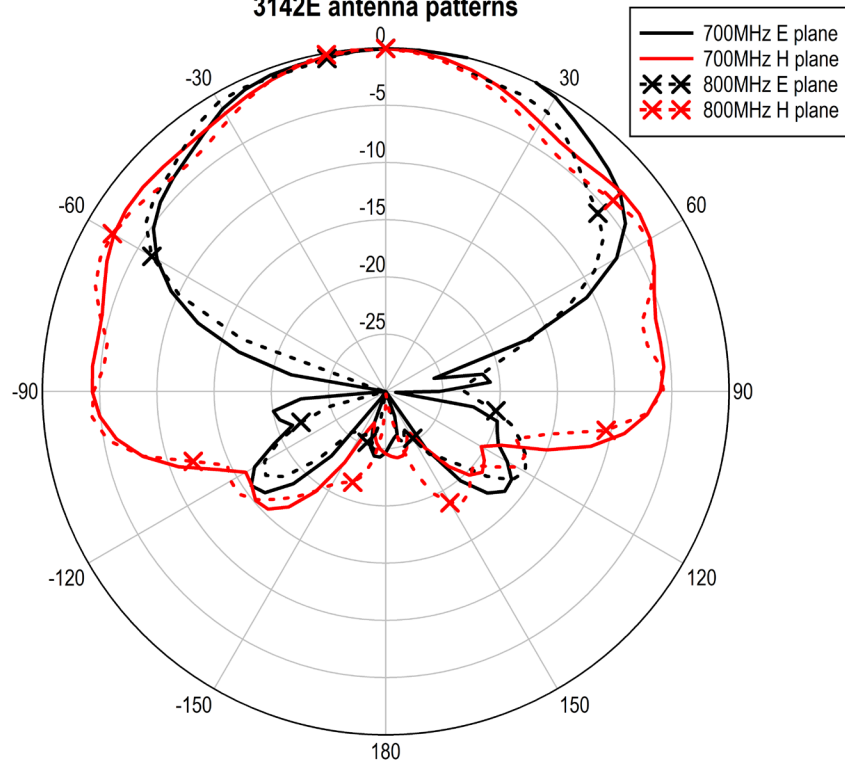

## 900MHz-1000MHz

### 3142E antenna patterns

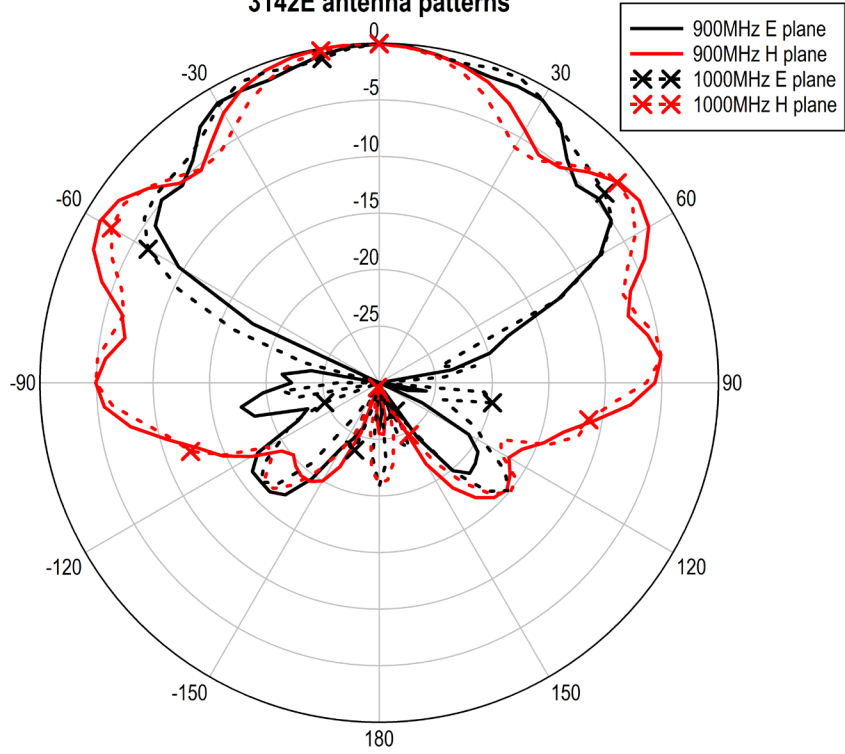

## 2000MHz-3000MHz

### 3142E antenna patterns

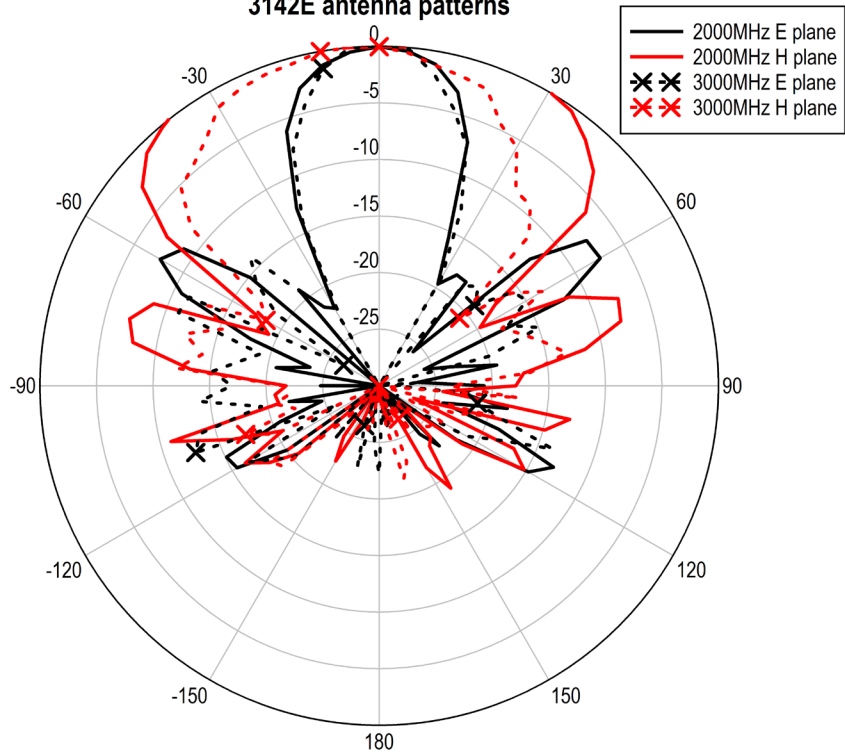

## 4000MHz-5000MHz

### 3142E antenna patterns

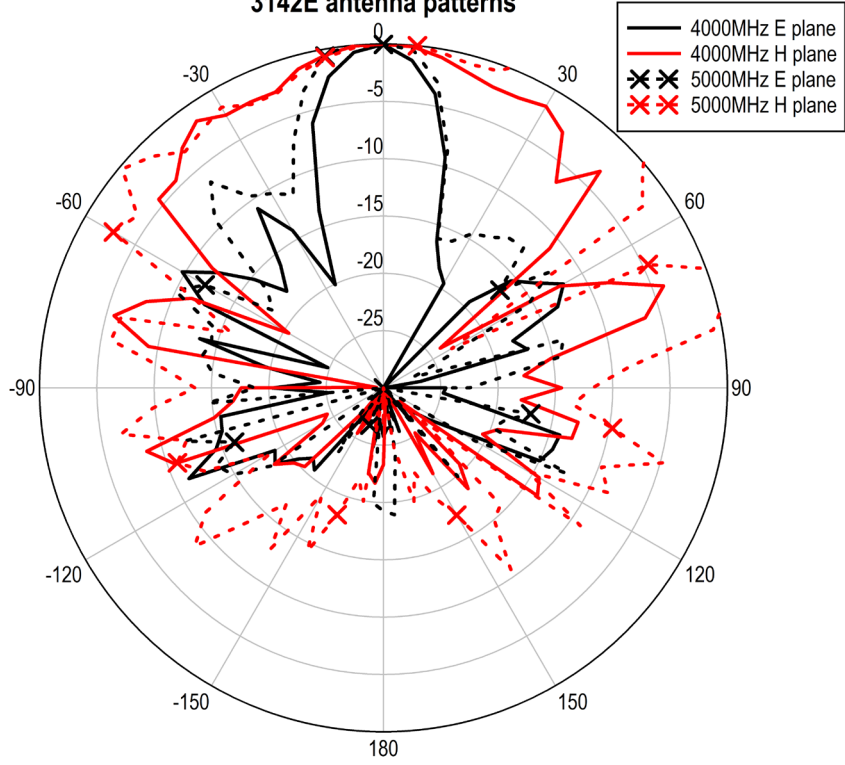

## 6000MHz

### 3142E antenna patterns

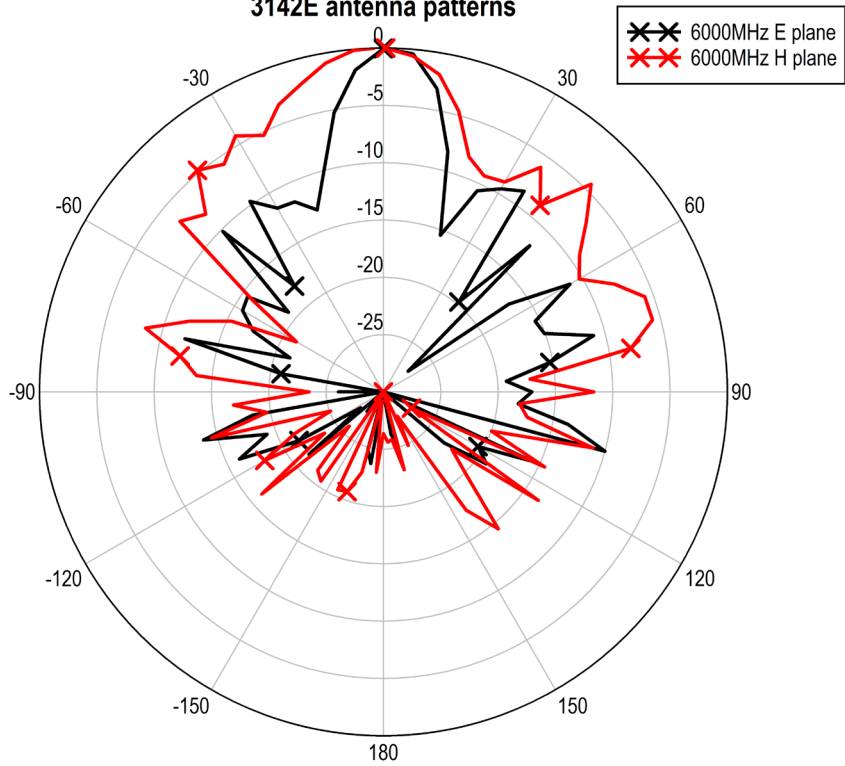



## Typical Cross Polarization

